

Notice for TAIYO YUDEN products

Please read this notice before using the TAIYO YUDEN products.

REMINDERS

- Product information in this catalog is as of October 2016. All of the contents specified herein are subject to change without notice due to technical improvements, etc. Therefore, please check for the latest information carefully before practical application or use of our products.

Please note that TAIYO YUDEN shall not be in any way responsible for any damages and defects in products or equipment incorporating our products, which are caused under the conditions other than those specified in this catalog or individual specification.

- Please contact TAIYO YUDEN for further details of product specifications as the individual specification is available.
- Please conduct validation and verification of our products in actual condition of mounting and operating environment before using our products.
- The products listed in this catalog are intended for use in general electronic equipment (e.g., AV equipment, OA equipment, home electric appliances, office equipment, information and communication equipment including, without limitation, mobile phone, and PC). Please be sure to contact TAIYO YUDEN for further information before using the products for any equipment which may directly cause loss of human life or bodily injury (e.g., transportation equipment including, without limitation, automotive powertrain control system, train control system, and ship control system, traffic signal equipment, disaster prevention equipment, medical equipment, highly public information network equipment including, without limitation, telephone exchange, and base station).

Please do not incorporate our products into any equipment requiring high levels of safety and/or reliability (e.g., aerospace equipment, aviation equipment, nuclear control equipment, undersea equipment, military equipment).

When our products are used even for high safety and/or reliability-required devices or circuits of general electronic equipment, it is strongly recommended to perform a thorough safety evaluation prior to use of our products and to install a protection circuit as necessary.

Please note that unless you obtain prior written consent of TAIYO YUDEN, TAIYO YUDEN shall not be in any way responsible for any damages incurred by you or third parties arising from use of the products listed in this catalog for any equipment requiring inquiry to TAIYO YUDEN or prohibited for use by TAIYO YUDEN as described above.

- Please note that TAIYO YUDEN shall have no responsibility for any controversies or disputes that may occur in connection with a third party's intellectual property rights and other related rights arising from use of our products. TAIYO YUDEN grants no license for such rights.
- Please note that unless otherwise agreed in writing, the scope of warranty for our products is limited to the delivered our products themselves and TAIYO YUDEN shall not be in any way responsible for any damages resulting from a fault or defect in our products.
- The contents of this catalog are applicable to our products which are purchased from our sales offices or authorized distributors (hereinafter "TAIYO YUDEN's official sales channel"). Please note that the contents of this catalog are not applicable to our products purchased from any seller other than TAIYO YUDEN's official sales channel.

■ Caution for Export

Some of our products listed in this catalog may require specific procedures for export according to "U.S. Export Administration Regulations", "Foreign Exchange and Foreign Trade Control Law" of Japan, and other applicable regulations. Should you have any questions on this matter, please contact our sales staff.



REFLOW

PARTS NUMBER

(A) Previous Rule (applied products registered on March 31, 2010 or before.)

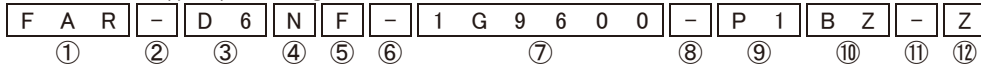

- | <p>① Family</p> <p>② Common sign</p> <p>③ Series name</p> <table border="1" style="width: 100%; border-collapse: collapse;"> <thead> <tr> <th style="width: 15%;">Code</th> <th style="width: 35%;">Product</th> <th style="width: 50%;">Frequency Range [MHz]</th> </tr> </thead> <tbody> <tr><td>D5</td><td>Duplexer</td><td>700 - 1000</td></tr> <tr><td>D6</td><td>Duplexer</td><td>1000 - 5000</td></tr> <tr><td>J5</td><td>Dual Duplexers</td><td>700 - 1000</td></tr> <tr><td>F5</td><td>Device</td><td>700 - 1000</td></tr> <tr><td>F6</td><td>Device</td><td>1000 - 5000</td></tr> <tr><td>G5</td><td>Dual Devices</td><td>700 - 1000</td></tr> <tr><td>G6</td><td>Dual Devices</td><td>1000 - 5000</td></tr> </tbody> </table> | Code | Product | Frequency Range [MHz] | D5 | Duplexer | 700 - 1000 | D6 | Duplexer | 1000 - 5000 | J5 | Dual Duplexers | 700 - 1000 | F5 | Device | 700 - 1000 | F6 | Device | 1000 - 5000 | G5 | Dual Devices | 700 - 1000 | G6 | Dual Devices | 1000 - 5000 | <p>④ Package code</p> <p>⑤ Product code</p> <p>⑥ Common sign</p> <p>⑦ Frequency</p> <p>⑧ Common sign</p> <p>⑨ Internal code</p> <p>⑩ Internal code</p> <p>⑪ Custom code</p> <p>⑫ Packaging</p> |
|--|----------------|-----------------------|-----------------------|----|----------|------------|----|----------|-------------|----|----------------|------------|----|--------|------------|----|--------|-------------|----|--------------|------------|----|--------------|-------------|--|
| Code | Product | Frequency Range [MHz] | | | | | | | | | | | | | | | | | | | | | | | |
| D5 | Duplexer | 700 - 1000 | | | | | | | | | | | | | | | | | | | | | | | |
| D6 | Duplexer | 1000 - 5000 | | | | | | | | | | | | | | | | | | | | | | | |
| J5 | Dual Duplexers | 700 - 1000 | | | | | | | | | | | | | | | | | | | | | | | |
| F5 | Device | 700 - 1000 | | | | | | | | | | | | | | | | | | | | | | | |
| F6 | Device | 1000 - 5000 | | | | | | | | | | | | | | | | | | | | | | | |
| G5 | Dual Devices | 700 - 1000 | | | | | | | | | | | | | | | | | | | | | | | |
| G6 | Dual Devices | 1000 - 5000 | | | | | | | | | | | | | | | | | | | | | | | |

(B) New Rule (applied to products registered on April 1, 2010 or later.)

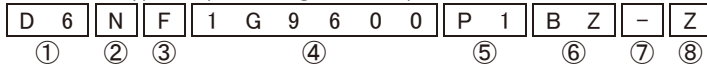

- | <p>① Series name</p> <table border="1" style="width: 100%; border-collapse: collapse;"> <thead> <tr> <th style="width: 15%;">Code</th> <th style="width: 35%;">Product</th> <th style="width: 50%;">Frequency Range [MHz]</th> </tr> </thead> <tbody> <tr><td>D5</td><td>Duplexer</td><td>700 - 1000</td></tr> <tr><td>D6</td><td>Duplexer</td><td>1000 - 5000</td></tr> <tr><td>J5</td><td>Dual Duplexers</td><td>700 - 1000</td></tr> <tr><td>F5</td><td>Device</td><td>700 - 1000</td></tr> <tr><td>F6</td><td>Device</td><td>1000 - 5000</td></tr> <tr><td>G5</td><td>Dual Devices</td><td>700 - 1000</td></tr> <tr><td>G6</td><td>Dual Devices</td><td>1000 - 5000</td></tr> </tbody> </table> | Code | Product | Frequency Range [MHz] | D5 | Duplexer | 700 - 1000 | D6 | Duplexer | 1000 - 5000 | J5 | Dual Duplexers | 700 - 1000 | F5 | Device | 700 - 1000 | F6 | Device | 1000 - 5000 | G5 | Dual Devices | 700 - 1000 | G6 | Dual Devices | 1000 - 5000 | <p>② Package code</p> <p>③ Product code</p> <p>④ Frequency</p> <p>⑤ Internal code</p> <p>⑥ Internal code</p> <p>⑦ Custom code</p> <p>⑧ Packaging</p> |
|---|----------------|-----------------------|-----------------------|----|----------|------------|----|----------|-------------|----|----------------|------------|----|--------|------------|----|--------|-------------|----|--------------|------------|----|--------------|-------------|--|
| Code | Product | Frequency Range [MHz] | | | | | | | | | | | | | | | | | | | | | | | |
| D5 | Duplexer | 700 - 1000 | | | | | | | | | | | | | | | | | | | | | | | |
| D6 | Duplexer | 1000 - 5000 | | | | | | | | | | | | | | | | | | | | | | | |
| J5 | Dual Duplexers | 700 - 1000 | | | | | | | | | | | | | | | | | | | | | | | |
| F5 | Device | 700 - 1000 | | | | | | | | | | | | | | | | | | | | | | | |
| F6 | Device | 1000 - 5000 | | | | | | | | | | | | | | | | | | | | | | | |
| G5 | Dual Devices | 700 - 1000 | | | | | | | | | | | | | | | | | | | | | | | |
| G6 | Dual Devices | 1000 - 5000 | | | | | | | | | | | | | | | | | | | | | | | |

*For further details, please contact to TAIYO YUDEN CO., LTD.

EXTERNAL DIMENSIONS

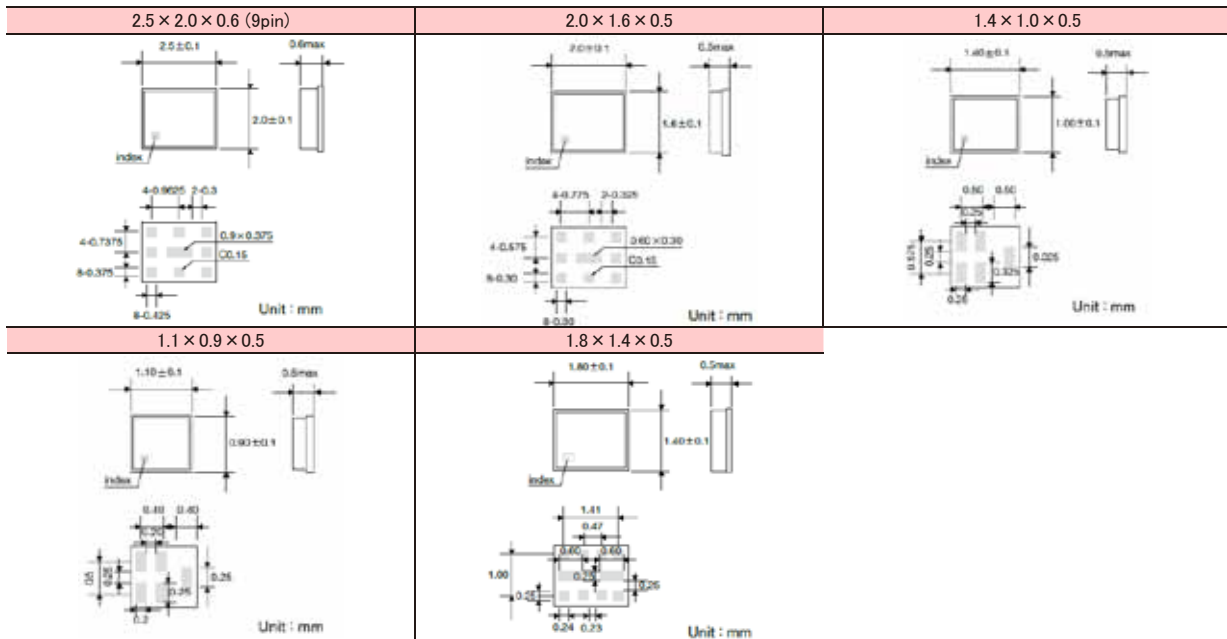

► This catalog contains the typical specification only due to the limitation of space. When you consider the purchase of our products, please check our specification. For details of each product (characteristics graph, reliability information, precautions for use, and so on), see our website (<http://www.ty-top.com/>).

Duplexers

System	Part number	Package Size [mm]	Insertion Loss [dB]	Attenuation [dB]	Remarks
W-CDMA Band 1	D6PE2G140P3AW	2.0 × 1.6 × 0.5	1.5/1.6	59/47	9 Pin, B Type Rx : Bal.100ohm
	D6DA2G140K2A4	1.8 × 1.4 × 0.5	1.8/1.8	56/51	8 Pin, B Type
	D6DA2G140K2A7	2.0 × 1.6 × 0.5	1.6/1.7	58/59	8 Pin, B Type
	D6RB2G140E1AJ	1.8 × 1.4 × 0.5	1.7/1.8	57/48	8 Pin, B Type Rx : Bal.100ohm
	D6RB2G140E1AL	1.8 × 1.4 × 0.47	1.7/1.8	57/51	8 Pin, B Type Rx : Bal.100ohm
PCS/W-CDMA Band 2	D6PF1G960M3B6	2.0 × 1.6 × 0.57	2.2/2.7	55/52	9 Pin, B Type
	D6PF1G960M3B9	2.0 × 1.6 × 0.57	2.2/2.7	57/52	9 Pin, B Type
	D6DA1G960K2B1	1.8 × 1.4 × 0.57	1.9/2.5	50/50	8 Pin, B Type
	D6PE1G960P3BY	2.0 × 1.6 × 0.57	2.0/3.1	57/53	9 Pin, B Type Rx : Bal.100ohm
	D6PE1G960P3BP	2.0 × 1.6 × 0.5	2.3/3.0	56/52	9 Pin, B Type Rx : Bal.100ohm
	D6RB1G960E1HB	1.8 × 1.4 × 0.5	2.1/2.9	56/55	8 Pin, B Type Rx : Bal.100ohm
LTE Band 3	D6DA1G842K2C4	1.8 × 1.4 × 0.6	2.3/2.1	56/56	8 Pin, B Type
W-CDMA/LTE Band 4	D6DA2G132K2D4	1.8 × 1.4 × 0.5	1.5/1.7	57/55	8 Pin, B Type
	D6DA2G132K2D9	1.8 × 1.4 × 0.5	1.6/1.8	60/56	8 Pin, B Type
	D6PE2G132P3DWB	2.0 × 1.6 × 0.5	1.8/1.8	55/50	9 Pin, B Type Rx : Bal.100ohm
	D6RB2G132E1DF	1.8 × 1.4 × 0.5	1.6/1.8	62/54	8 Pin, B Type Rx : Bal.100ohm
	CDMA/W-CDMA Band 5	FAR-D5PF-881M50-M3E7	2.0 × 1.6 × 0.5	1.5/1.8	58/51
FAR-D5PF-881M50-M3E9		2.0 × 1.6 × 0.5	1.5/1.8	58/51	9 Pin, B Type
FAR-D5PE-881M50-P3EZ		2.0 × 1.6 × 0.5	1.4/1.7	59/52	9 Pin, B Type Rx : Bal.100ohm
FAR-D5PE-881M50-P3EY		2.0 × 1.6 × 0.5	1.4/1.7	59/52	9 Pin, A Type Rx : Bal.100ohm
D5DA881M5K2E4		1.8 × 1.4 × 0.5	1.4/1.7	58/59	8 Pin, B Type
D5RB881M5E1BH		1.8 × 1.4 × 0.47	1.4/1.7	58/52	8 Pin, B Type Rx : Bal.100ohm
LTE Band 7		D6HL2G655DL06	2.0 × 1.6 × 0.54	2.1/2.3	53/57
	D6HQ2G655DP01	1.8 × 1.4 × 0.54	2.3/2.2	58/57	8 Pin, B Type FBAR
	D6HN2G655BN54	2.0 × 1.6 × 0.54	1.8/2.6	55/56	9 Pin, B Type Bal.100ohm, FBAR WLAN coexistence Ver.
	D6HP2G655BP11	1.8 × 1.4 × 0.54	1.8/2.4	56/56	8 Pin, B Type Bal.100ohm, FBAR
	W-CDMA Band 8	D5PF942M5M3G6	2.0 × 1.6 × 0.5	2.1/2.1	57/55
D5PF942M5M3G9		2.0 × 1.6 × 0.5	1.9/2.2	60/52	9 Pin, B Type
D5DA942M5K2G6		1.8 × 1.4 × 0.5	1.7/1.8	58/59	8 Pin, B Type
D5DA942M5K2S2		1.8 × 1.4 × 0.6	1.3/1.5	58/56	for LTE 8 Pin, B Type
D5PE942M5P3GT		2.0 × 1.6 × 0.5	1.7/2.2	58/54	9 Pin, B Type Rx : Bal.100ohm
D5RB942M5E1CF		1.8 × 1.4 × 0.5	1.5/1.9	56/51	8 Pin, B Type Rx : Bal.100ohm
LTE Band 12		D5DA737M5K2H2	1.8 × 1.4 × 0.5	1.65/1.65	63/58
	LTE Band 13	D5PE782MOM3P9	2.0 × 1.6 × 0.5	1.6/2.0	64/55
LTE Band 13+17 Triplexer		D5DA782MOK2J6	1.8 × 1.4 × 0.5	1.9/1.7	58/61
	LTE Band 17	J5NA782MOP1H6	2.5 × 2.0 × 0.6	1.6/1.9 1.9/1.9	60/53 53/55
D5PF740MOM3R9		2.0 × 1.6 × 0.5	1.6/1.8	50/50	9 Pin, B Type
D5DA740MOK2L4		1.8 × 1.4 × 0.5	1.25/1.65	65/60	8 Pin, B Type
D5PE740MOP3NZ		2.0 × 1.6 × 0.5	1.9/2.0	63/60	9 Pin, B Type Rx : Bal.100ohm
D6PE1G503P3KW		2.0 × 1.6 × 0.5	1.6/2.0	55/56	9 Pin, B Type Rx : Bal.100ohm
LTE Band 21	D6HL1G962DL39	2.0 × 1.6 × 0.57	2.4/2.9	56/51	9 Pin, B Type FBAR
	D6HQ1G962DP39	1.8 × 1.4 × 0.57	2.4/2.7	57/52	8 Pin, B Type FBAR
LTE Band 25	D5PF876M5M3U9	2.0 × 1.6 × 0.5	2.0/1.9	66/49	
	D5DA876M5K2P6	1.8 × 1.4 × 0.6	1.3/2.0	60/57	8 Pin, B Type
	D5PE876M5P3UZ	2.0 × 1.6 × 0.5	2.2/2.6	60/49	9 Pin, B Type Rx : Bal.100ohm
LTE Band 28	D5PF773MOM3Y6	2.0 × 1.6 × 0.5	1.8/2.3	60/53	Block A 9Pin, B Type
	D5PF788MOM3Y9	2.0 × 1.6 × 0.5	1.8/2.4	60/54	Block B 9Pin, B Type
	CDMA BC0+BC10	D5PE878MOP3UT	2.0 × 1.6 × 0.5	1.9/2.2	59/51

► This catalog contains the typical specification only due to the limitation of space. When you consider the purchase of our products, please check our specification. For details of each product (characteristics graph, reliability information, precautions for use, and so on), see our website (<http://www.ty-top.com/>).

● W-CDMA / LTE / CDMA 2000 Filters

System	Part number	Package Size [mm]	Insertion Loss [dB]	Attenuation [dB]	Remarks
Band 1 Tx	F6QA1G950M2AA	1.1 × 0.9 × 0.5	1.8	38	Low loss, High Att.
Band 1, Band 4 Rx	F6QA2G140M2AM	1.1 × 0.9 × 0.5	1.9	46	Unbal.
	F6QG2G140P2KA	1.1 × 0.9 × 0.5	1.7	55	100ohm, High Att.
Band 2 Tx BC1(PCS) Tx	F6QA1G880M2AQ	1.1 × 0.9 × 0.5	1.7	20	
Band 2 Rx BC1(PCS) Rx	F6QA1G960M2AP	1.1 × 0.9 × 0.5	2.8	39	High Att.
	F6QG1G960P2KT	1.1 × 0.9 × 0.5	2.8	44	100ohm output
Band 3 Tx	F6QA1G747M2QS	1.1 × 0.9 × 0.5	2.1	22	
Band 3 Rx	F6QA1G842M2AN	1.1 × 0.9 × 0.5	2.0	38	Unbal.
	F6QG1G842P2KD	1.1 × 0.9 × 0.5	3.2	45	100ohm output
	F5QA836M5M2AR	1.1 × 0.9 × 0.5	1.9	45	High Att.
Band 5 Tx BC0 Tx	F5QA881M5M2AU	1.1 × 0.9 × 0.5	1.3	51	Low Loss/high Att.
Band 5 Rx BC0 Rx	F5QG881M5P2KG	1.1 × 0.9 × 0.5	1.5	56	100ohm, High Att., Low Loss
	F6QA2G635M2QH	1.1 × 0.9 × 0.5	2.5	38	Unbal.
Band 7 Rx	F6QG2G655P2KE	1.1 × 0.9 × 0.5	2.5	52	100ohm, High Att.
	F5QA897M5M2AC	1.1 × 0.9 × 0.5	2.3	18	-
Band 8 Tx	F5QA942M5M2AW	1.1 × 0.9 × 0.5	2.0	48	for LTE
	F5QG942M5P2KB	1.1 × 0.9 × 0.5	2.2	56	100ohm, High Att.
	F5QG942M5P2KF	1.1 × 0.9 × 0.5	2.2	60	100ohm output for LTE
Band 12 Rx	F5QA737M5M2QN	1.1 × 0.9 × 0.5	1.6	53	Unbal.
	F5QG737M5P2KK	1.1 × 0.9 × 0.5	1.6	55	100ohm output
Band 13 Tx	F5QA782M0M2AZ	1.1 × 0.9 × 0.5	1.5	56	Unbal.
Band 13 Rx	F5QA751M0M2QM	1.1 × 0.9 × 0.5	1.9	50	Unbal.
Band 14	F5QA763M0M2QL	1.1 × 0.9 × 0.5	2.2	49	Unbal.
Band 17 Tx	F5QA710M0M2AY	1.1 × 0.9 × 0.5	1.3	33	Unbal.
Band 17 Rx	F5QG740M0P2KH	1.1 × 0.9 × 0.5	1.4	65	100ohm output
Band 20 Rx	F5QA806M0M2QE	1.1 × 0.9 × 0.5	2.7	41	Unbal.
Band 21 Rx	F6QA1G503M2QF	1.1 × 0.9 × 0.5	2.0	52	Unbal.
Band 25 Tx	F6QA1G882M2AS	1.1 × 0.9 × 0.5	1.8	23	Unbal.
Band 26 Rx	F5QA876M5M2QP	1.1 × 0.9 × 0.5	2.2	49	Unbal.
	F5QG876M5P2KQ	1.1 × 0.9 × 0.5	2.2	59	100ohm output
Band 28 Rx	F5QA773M0M2QC	1.1 × 0.9 × 0.5	2.1	52	Block A
	F5QA788M0M2QB	1.1 × 0.9 × 0.5	2.0	52	Block B
Band 29 Rx	F5BA722M5M6UW	1.1 × 0.9 × 0.44	1.6	38	Unbal.
Band 30 Rx	F6QP2G355R2SE	1.1 × 0.9 × 0.5	2.1	50	Unbal.
Band 32 Rx	F6QA1G474H2JS	1.1 × 0.9 × 0.5	1.8	-	Unbal.

● TDD Filters (TD-SCDMA / TD-LTE)

System	Part number	Package Size [mm]	Insertion Loss [dB]	Attenuation [dB]	Remarks
Bnad 38 Tx	F6KA2G595A4VL	1.4 × 1.0 × 0.5	1.5	-	Input Power +29dBm
Bnad 38 Rx	F6QA2G595M2QK	1.1 × 0.9 × 0.5	1.9	-	
	F6QB2G595P2BS	1.1 × 0.9 × 0.5	2.0	-	Balanced 100ohm
Band 39 Rx	F6QA1G900M2WD	1.1 × 0.9 × 0.5	1.5	-	
Band 40 Tx	F6HF2G350AF41	1.4 × 1.0 × 0.6	2.3	-	Input Power +29dBm FBAR
Band 40 Rx	F6QA2G350M2QA	1.1 × 0.9 × 0.5	2.2	-	
	F6QB2G350P2BH	1.1 × 0.9 × 0.5	2.8	-	Balanced 100ohm
Band 41	F6KA2G605A4LA	1.4 × 1.0 × 0.5	2.4	-	Unbal High power design 2555-2655MHz BW100MHz
	F6HP2G593AP20	2.0 × 1.6 × 0.6	2.9	-	Unbal High power design 2496-2690MHz BW194MHz

● TDD Dual Filters (TD-SCDMA / TD-LTE)

System	Part number	Package Size [mm]	Insertion Loss [dB]	Attenuation [dB]	Remarks
Band 39 Rx + 41(BW100MHz) TRx(Common Input)	G6KJ2G605D4AB	1.8 × 1.4 × 0.5	2.1/2.6	-	B41 High power design B41 (2555-2655MHz BW100MHz) for CMCC CA

● GPS

System	Part number	Package Size [mm]	Insertion Loss [dB]	Attenuation [dB]	Remarks
GPS	F6QA1G575H2JF	1.1 × 0.9 × 0.5	0.96	-	Low loss, High Att.
GPS (GNSS)	F6QA1G585M2AT	1.1 × 0.9 × 0.5	1.4	-	-
	F6QB1G585P2BQ	1.1 × 0.9 × 0.5	1.7	-	100ohm output
GPS+GLONASS+Galileo+Compass	F6QA1G581M2QZ	1.1 × 0.9 × 0.5	1.4	-	
	F6QA1G582H2JM	1.1 × 0.9 × 0.5	1.8	-	Ladder High Att.
	F6BG1G582R6TT	1.1 × 0.9 × 0.44	1.7	-	100ohm output

● Others

System	Part number	Package Size [mm]	Insertion Loss [dB]	Attenuation [dB]	Remarks
ISM900 (B.W.26MHz)	FAR-F5QA-915M00-M2AK	1.1 × 0.9 × 0.5	1.8	-	
Wireless LAN / Bluetooth®	FAR-F6KA-2G4418-A4VA	1.4 × 1.0 × 0.5	3.0	-	+23dBm
	FAR-F6KA-2G4500-A4VD	1.4 × 1.0 × 0.5	1.9	-	Low IL,+19dBm
	F6KA2G436A4VE	1.4 × 1.0 × 0.5	2.5	-	BW=72MHz,+24dBm
	F6KA2G466A4VJ	1.4 × 1.0 × 0.5	2.8	-	BW=68MHz,+24dBm
	F6HF2G441AF46	1.4 × 1.0 × 0.6	1.6	-	2402.5-2481.5MHz Input Power +28dBm FBAR
	F6HG2G441EG65	1.1 × 0.9 × 0.5	1.3	-	FBAR

FBAR/SAW DEVICES for MOBILE COMMUNICATIONS

PACKAGING

① Minimum Quantity

Type	Size (mm)	Code & Quantity (Pieces)							
Duplexer	3.0 × 2.5	Z	3000			U	10000		
	2.5 × 2.0	Z	3000			U	10000		
	2.0 × 1.6	Z	3000					Y	15000
Single Filter	2.0 × 1.6	Z	3000					Y	15000
	1.4 × 1.0	Z	3000					Y	15000
	1.1 × 0.9			J	5000			Y	15000
Dual Filter	2.0 × 1.6	Z	3000					Y	15000
	1.8 × 1.4	Z	3000					Y	15000
	1.5 × 1.1			J	5000			Y	15000

② Tape material

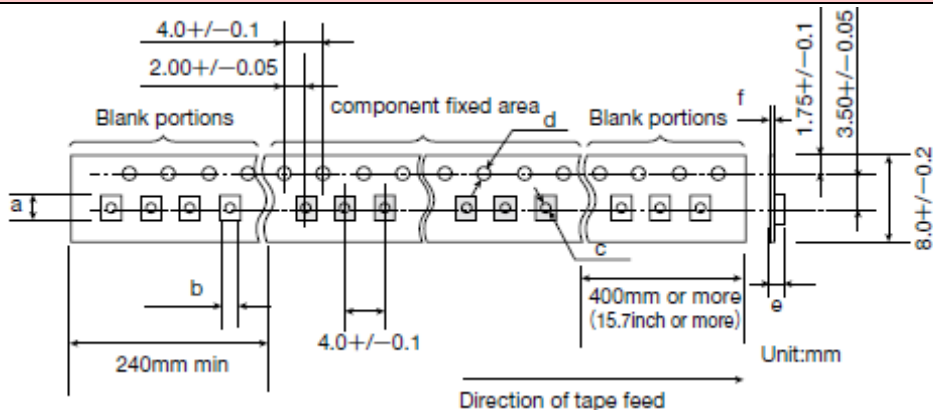

● Taping dimensions

Type	Size (mm)	a	b	c	d	e	f
Duplexer	3.0 × 2.5	3.4 ± 0.1	2.85 ± 0.1	1.05 ± 0.05	1.55 ± 0.05	1.0 ± 0.1	0.25 ± 0.05
	2.5 × 2.0	2.8 ± 0.1	2.3 ± 0.1	1.5 + 0.1 / - 0	1.5 + 0.1 / - 0	1.0 + 0.1 / - 0.0	0.25 ± 0.05
	2.0 × 1.6	2.4 ± 0.1	2.0 ± 0.1	1.05 ± 0.05	1.5 + 0.1 / - 0	0.90 - 0.05	0.25 ± 0.05
Single Filter	2.0 × 1.6	2.4 ± 0.1	2.0 ± 0.1	1.05 ± 0.05	1.5 + 0.1 / - 0	0.90 - 0.05	0.25 ± 0.05
	1.4 × 1.0	1.7 ± 0.1	1.3 ± 0.1	0.5 ± 0.05	1.5 + 0.1 / - 0	0.63 ± 0.05	0.20 ± 0.05
	1.1 × 0.9	1.3 ± 0.1	1.1 ± 0.1	0.5 ± 0.05	1.55 ± 0.05	0.63 ± 0.05	0.20 ± 0.05
Dual Filter	2.0 × 1.6	2.4 ± 0.1	2.0 ± 0.1	1.05 ± 0.05	1.5 + 0.1 / - 0	0.90 - 0.05	0.25 ± 0.05
	1.8 × 1.4	2.2 ± 0.1	1.8 ± 0.1	0.5 ± 0.05	1.55 ± 0.05	0.8 ± 0.1	0.30 ± 0.05
	1.5 × 1.1	1.8 ± 0.1	1.4 ± 0.1	0.5 ± 0.05	1.5 + 0.1 / - 0	0.7 ± 0.1	0.25 ± 0.05

Unit: mm

● Material of Tape (Conductive)

Tape : Polystyrene

Top cover tape : Polyethylene terephthalate (PET) and Polyethylene

③ Top Tape Strength

The top tape requires a peel-off force of 0.1 to 1.0N in the direction of the arrow as illustrated below.

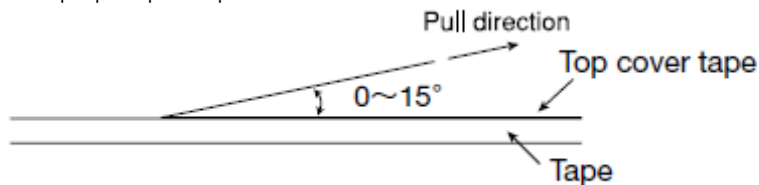

④ Reel size

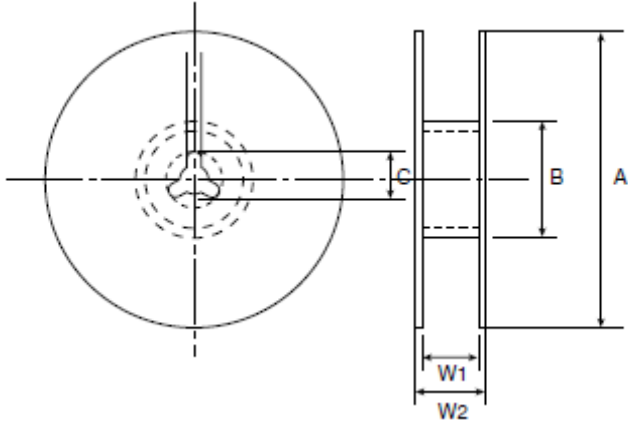

● Material of Reel

Material : Polystyrene + Carbon

Characteristics : Conform to EIAJ-ET-7200A

Color : Black

Surface resistance (reference value) : 109 Ω/sq Max.

Code	Quantity	A	B	C	W1	W2
Z	3,000 pcs	φ180.0 +0.0/-1.5	φ66.0 ±0.5	φ13.0 ±0.2	9.0 +1.0/-0.0	11.4 ±1.0
J	5,000 pcs	φ180.0 +0.0/-1.5	φ66.0 ±0.5	φ13.0 ±0.2	9.0 +1.0/-0.0	11.4 ±1.0
U	10,000 pcs	φ330.0 ±2.0	φ100.0 ±1.0	φ13.0 ±0.2	9.4 ±1.0	13.4 ±1.0
Y	15,000 pcs	φ330.0 ±2.0	φ100.0 ±1.0	φ13.0 ±0.2	9.4 ±1.0	13.4 ±1.0

Unit : mm

⑤ Reel label and Reel C-Label sticking and Winding method

● Surface

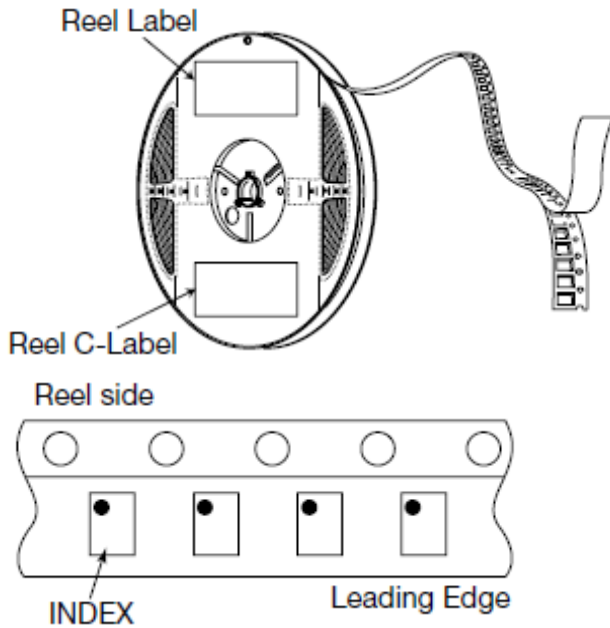

FBAR/SAW DEVICES for MOBILE COMMUNICATIONS

RELIABILITY DATA

1. Terminal strength	
Specified Value	No damage to be found.
Test Methods and Remarks	<p>Bend width 4mm, hold for 5 ± 1 sec. according to IEC60068-2-21(JISC60068-2-21)</p> <p>Unit : mm</p>
2. Mechanical shock	
Specified Value	After testing, meet the specified characteristics at a room temperature.
Test Methods and Remarks	Apply 14700m/s^2 for 0.5ms 5 times for each of 6 directions. according to IEC68-2-27(JISC60068-2-27).
3. Vibration	
Specified Value	After testing, meet the specified characteristics at a room temperature.
Test Methods and Remarks	With 1.5 mm of whole amplitude at 10 to 55 Hz of frequency, and 98m/s^2 of acceleration at 55 to 500Hz, apply a vibration for 2 hours for each of 3 directions, period is 15 minutes(10 to 500 to 10Hz)
4. Drop 1	
Specified Value	After testing, meet the specified characteristics at a room temperature.
Test Methods and Remarks	Drop 3 times onto concrete floor from the height of 1.0m.
5. Drop 2	
Specified Value	After testing, meet the specified characteristics at a room temperature.
Test Methods and Remarks	Drop with 150g weight 3 times in each 6 direction onto concrete floor from the height of 1.8m.
6. Temperature cycling	
Specified Value	After testing, meet the specified characteristics at a room temperature.
Test Methods and Remarks	Temp. range -40 to $+100^\circ\text{C}$. 500cycle.
7. Static humidity	
Specified Value	After testing, meet the specified characteristics at a room temperature.
Test Methods and Remarks	$+85^\circ\text{C}$, 90% to 95%RH, apply DC5V, 1000hours.
8. High temperature storage life	
Specified Value	After testing, meet the specified characteristics at a room temperature.
Test Methods and Remarks	$+100^\circ\text{C}$, 1000hours.
9. Low temperature storage life	
Specified Value	After testing, meet the specified characteristics at a room temperature.
Test Methods and Remarks	-40°C , 1000hours.

▶ This catalog contains the typical specification only due to the limitation of space. When you consider the purchase of our products, please check our specification. For details of each product (characteristics graph, reliability information, precautions for use, and so on), see our Web site (<http://www.ty-top.com/>).

10. High Temperature Bias (Duplexer only)	
Specified Value	After testing, meet the specified characteristics at a room temperature.
Test Methods and Remarks	+50°C, +29dBm, 50000hours.
11. Solderbility 1	
Specified Value	More than 90% of area of terminals to be covered with the solder. A change of the remarkable appearance do not have it.
Test Methods and Remarks	Lead-free Solder paste, Reflow; Peak temperature 245°C
12. Solderbility 2	
Specified Value	More than 90% of area of terminals to be covered with the solder. A change of the remarkable appearance do not have it.
Test Methods and Remarks	Sn-Pb Solder paste, Reflow; Peak temperature 235°C
13. Solder heat resistance	
Specified Value	After testing, meet the specified characteristics at a room temperature. A change of the remarkable appearance do not have it.
Test Methods and Remarks	<p>◆Recommended temperature profile of reflow soldering Figure shows recommended temperature profile of reflow soldering in the case of lead-free solder alloy Sn3.0Ag0.5Cu. Suitable condition for solder heating is differed depending on composition and manufacturing method. Please contact to solder manufacturer for the details.</p> <p>Temperature (°C)</p> <p>Ambient temperature rise slope : 1~4°C/sec.</p> <p>Pre-Heating 150~180°C</p> <p>50~110sec.</p> <p>30~50sec.</p> <p>10sec.</p> <p>Ambient temperature cool slope : 1~4°C/sec.</p> <p>Temperature in heat condition : 230°Cmin. 50sec. max. Temperature of upper surface of package and PCB surface : 260°Cmin. 10sec. max.</p>